



emco entrance matting systems

Strong protective shield for the entrance

Designing clean entrances.

EMCO

Contents

General and background knowledge

| | | |
|---|-------|----|
| This is why entrance matting systems are worthwhile | | 4 |
| emco advantages at a glance | | 6 |
| The emco 3-zone cleaning system | | 8 |
| Using 3-zone cleaning correctly | | 10 |

NEW!

emco products

| | | |
|--|-------|----|
| The difference between DIPLOMAT and MARSCHALL | | 12 |
| emco entrance mats Premium vs. emco entrance mats Original | | 14 |
| emco entrance mats Premium with Performance inserts | | 16 |
| emco entrance mats Original with standard inserts | | 18 |
| Dirt collection zones individually arranged | | 20 |
| emco installation frames and other accessories | | 22 |
| emco clean-off | | 24 |
| Clean-off in the entire building | | 26 |

emco special solutions

| | | |
|--------------------------|-------|----|
| emco special solutions | | 28 |
| Services | | 32 |
| International references | | 34 |



Gelderlandplein, Amsterdam (NL)

Architects: Rijnboutt Architecten, Amsterdam

Products: emco 3-zone cleaning with

emco **MARSCHALL PREMIUM**

Gelderlandplein



This is why entrance matting systems are worthwhile

Safe, clean, sensational

The entrance area is your building's ambassador. However, it is also the bottleneck through which everyone enters. This means that large quantities of street dirt accumulate here every day. An enormous challenge, which must be met intelligently. Entrance matting systems by emco provide systematic and powerful protection, like a protective shield. Not only dirt but accidents caused by slipping and damage have no chance. For a radiant first impression.

Did you know ...

... that emco entrance matting systems ensure the value of your building is consistently maintained?

Entrance areas are bottlenecks that every visitor passes through. The entrance area is therefore not only exposed to particular stress, it also protects the entire building from moisture, dirt and dust. This is why it needs valuable support. emco entrance matting systems protect every square metre of your property.

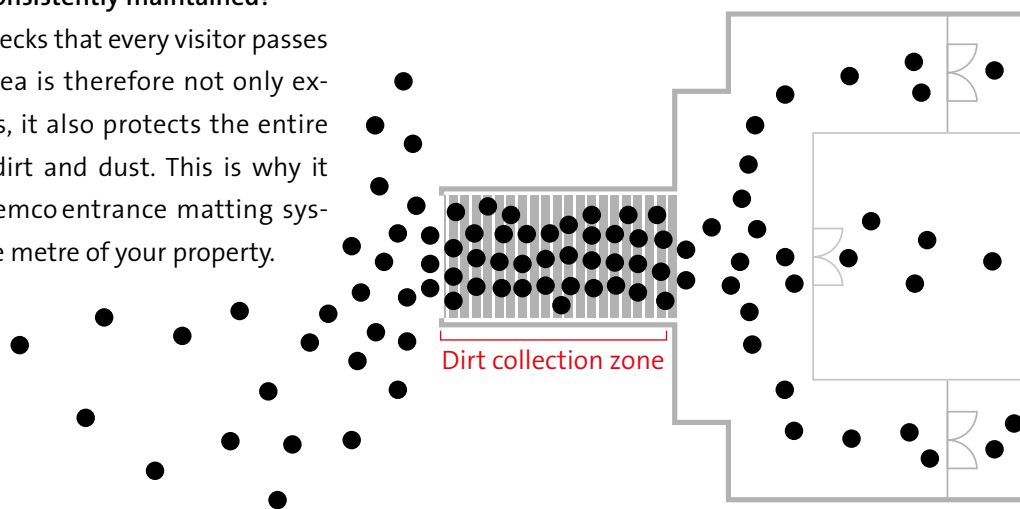



emco advantages at a glance

Highly convincing

As a strong protective shield for the entrance, emco entrance matting systems must be able to do much more than simply deal with dirt. They must always be ready for use, stand up to high stress and also be able to cope with crowds without any problems. The focus is equally on the protection of people and property. emco entrance matting systems score points with six outstanding advantages:

SAFE



Prevents accidents caused by slipping and is certified to ensure public safety

VALUE-PRESERVING



Prevents expensive damage to the internal floor covering which help retain the value of the property

TESTED



Offers certified products that have been put through their paces by TÜV (Technical Inspection Agency)

ECONOMICAL



Reduces the dirt carried into the building by up to 90%

SIMPLE



Extremely easy to install, especially with emco 360° service

SUSTAINABLE



Reduces the consumption of cleaning agents and supports LEED/BREEAM/DGNB certifications



The emco 3-zone cleaning system

3 power zones for spotless cleanliness

It is the combination of three different zones that makes the emco entrance matting system so powerful. Each individual zone is in itself extremely effective and enormously resilient, but together they develop their full power. The first zone has special inserts to prevent coarse dirt from entering the building. The second zone with a non-slip insert material ensures that fine and damp dirt is removed. The third zone absorbs residual moisture and dirt and not only helps prevent accidents caused by slipping, but also prevents dirt being brought into the building from the mats themselves. Only emco helps alleviate dirt by using there powerful triple action combination.

Did you know ...

... that emco entrance mats keep them selves perfectly clean?

Most of our emco entrance mats are designed in such a way that after the dirt has been removed, it falls through the gaps into the mat well. This guarantees their high degree of functionality. At the same time, emco entrance mats are particularly easy to clean because they can be rolled up. When it is time to clean the mat well, the entrance mat can simply be rolled up, lifted out and stored away. The mat can then simply be re- fitted with ease.





Dirt collection zone 1
Catches coarse dirt

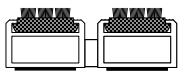

Dirt collection zone 2
Removes fine dirt
and moisture

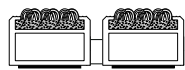

Dirt collection zone 3
Absorbs residual moisture
and dirt

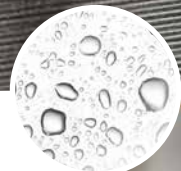

Using 3-zone cleaning correctly

Easy to install – threefold savings

Give your entrance matting system just as much attention as your internal floor covering – it is worth it, for emco 3-zone cleaning not only provides comprehensive protection against dirt and damage to internal floor finishes, it also ensures that expensive cleaning costs are reduced step by step. Each zone alone already reduces the need for cleaning, but when installed as a complete system, you will have the power of 3 zones that will reduce the dirt input by up to 90%.



Approx. 40%*
dirt reduction



Did you know ...

... that the perfect length of an entrance matting system is at least 9 metres?

In a worst-case scenario, every visitor carries up to 12 grams of dirt into a building. Course dirt, fine dirt, moisture and in winter, even aggressive de-icing salt. In order to collect all this dirt reliably, we recommend a 12 step contact or 3 wheelchair revolutions on our entrance matting system. With an average stride length of 75 cm, this means that the optimum length of the emco entrance matting system is at least 9 metres.

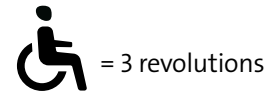
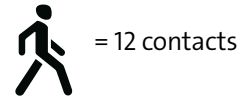

9 m

*when all three zones are combined

1 > 2 > 3

Dirt collection zone 3

The difference between DIPLOMAT and MARSCHALL

It comes down to the profile

We have extended our system so that you can choose your ideal emco entrance mat without having to consider the load or the installation requirements. All emco entrance mats are now available in the standard profile heights 12, 17 and 22 mm. And we have also optimised our profile widths for you: in the Premium variant, all inlays are now also available in a wide version. In the Original variant, the ribbed carpet inserts are available in a wide version as well. In addition to that, all emco entrance mats are available with two load capacities. The DIPLOMAT profile is the right choice for buildings with normal to heavy loads, while the MARSCHALL profile offers exceptional protection for extremely heavy loads. So you always have the right mat for the job. And if the requirements change, for example after renovation work, you can simply retrofit the existing system.

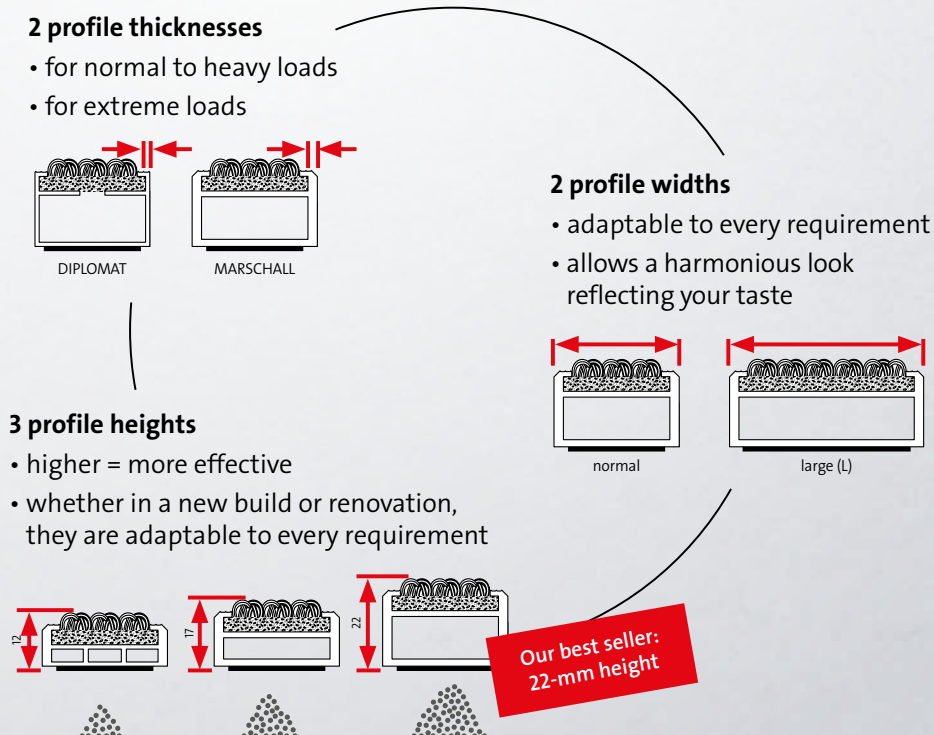



emco **MARSCHALL**



For entrances with extreme loads, e.g. shopping centres, airports, hospitals and railway stations.



emco **DIPLOMAT**



For entrances with normal to heavy loads, e.g. for residential, commercial and general office buildings



1

2

3

emco entrance mats Premium vs. emco entrance mats Original

You have the choice!

In addition to our Standard inserts, we have developed a range of completely new Performance inserts so that you can benefit from such strong properties as approved fire certification and reduction in walking noise. But no matter which format you choose, you can always be assured of a top quality matting system.

We have completely optimised our entrance matting system for you:



Easier orientation

Clear structuring of our products for even easier selection and combination



TÜV-certified products

Both our Premium and our Original products have been intensively tested by TÜV.



Consistent design

Thanks to the new variety of Performance inserts, you can easily develop a uniform design.



Greater efficiency

Our entrance mats now absorb even more dirt and moisture while reducing walking noise. They are also significantly more durable and abrasion-resistant.



System extension

Our entrance mats are now available in all standard profile heights and insert widths for normal and heavy loads (in the Premium version).

Entrance mats Original

- ✔ significant reduction in walking noise
- ✔ anti slip approved
- ✔ tested stress
- ✔ classic design

Entrance mats Premium

- ✔ more durable reduction in walking noise
- ✔ increased moisture absorption
- ✔ increased dirt absorption
- ✔ anti slip approved
- ✔ stress class suitable for properties
- ✔ approved fire certification
- ✔ uniform design
- ✔ compliance with emission regulations
- ✔ manufactured using polyamide

NEW!



emco entrance mats Premium with Performance inserts

DIPLOMAT PREMIUM and MARSCHALL PREMIUM

New variety with smart extras

1 2 3 Dirt collection zone 1

Colours

OUTDOOR insert// The special one

- ✓ also suitable for outdoor use
- ✓ good scraping properties
- ✓ optimum absorption of coarse dirt
- ✓ high abrasion resistance
- ✓ radiant colours

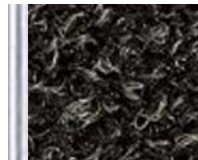

Anthracite 85.01



Brown 85.02



Red 85.03

1 2 3 Dirt collection zone 2

Colours

CARE insert// The robust one

- ✓ highly robust
- ✓ high light fastness
- ✓ effective dirt reduction
- ✓ effectively protects high-quality floor coverings

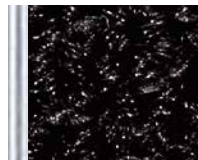

Anthracite 47.01



Grey 47.02

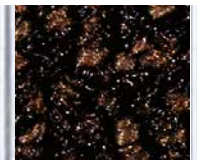

Brown 47.03



Beige 47.04

MAXIMUS/MAXIMUS IMAGE insert// The individual one

- ✓ individually printable (MAXIMUS IMAGE)
- ✓ high quality tufted velour
- ✓ excellent protective properties
- ✓ optimum yarn mix for absorbing dirt



Anthracite 80.02

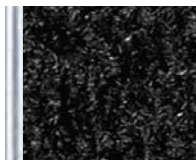

Black 80.01

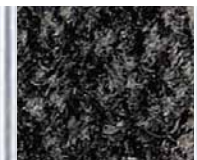

Black mottled 81.01



Brown 80.04

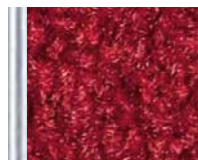

Red 80.07

Custom-printed
MAXIMUS IMAGE insert
available in 45 different
colours

AERO insert// The fine dust absorber one

- ✓ fine dust absorber
- ✓ elegant colouring
- ✓ made from regenerated resources (Econyl)
- ✓ carpet character



Anthracite
A886-9511

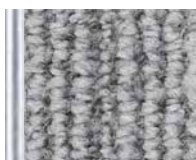

Grey
A886-1504

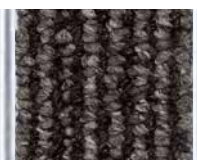

Brown
A886-9104



Beige
A886-1958

CONFORM insert// The ecological one

- ✓ exclusive velour
- ✓ made from regenerated resources (Econyl)
- ✓ highly versatile
- ✓ colouring specially matched to wood



Anthracite 76.01

Brown 76.04

Beige 76.02

INNOVA insert// The clever one

- ✓ hides dirt particularly well
- ✓ distinguished appearance
- ✓ consistent dirt reduction
- ✓ improves room acoustics



Anthracite 36.02

Grey 36.03

Black 36.01

www.emco-bau.com/Premium

The field of application

Depending on the type of load, you can choose between two different emco profiles for your entrance mat Premium with Performance insert:

**Our best seller:
22-mm height**



emco DIPLOMAT PREMIUM

For entrances with normal to heavy loads

- e. g. for residential, administrative and office buildings
- heights: 12, 17, 22 mm
- all inserts also available in a wide profile

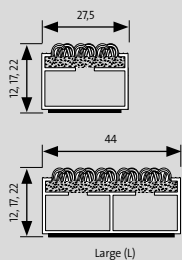

emco MARSCHALL PREMIUM

For entrances with extreme loads

- e. g. for shopping centres, airports, hospitals and railway stations
- heights: 12, 17, 22 mm
- all inserts also available in a wide profile

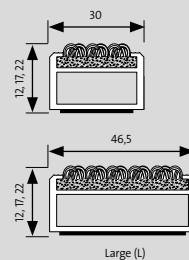



emco entrance mats Original with Standard inserts

DIPLOMAT ORIGINAL and MARSCHALL ORIGINAL

Proven quality and cleaning performance

1 2 3 Dirt collection zone 1

Colours

Rubber insert*

- ✓ for extra-large amounts of coarse dirt
- ✓ high abrasion resistance
- ✓ resistance to weathering
- ✓ elegant appearance
- ✓ also suitable for outdoor use



Black

Cassette brush insert*

- ✓ for extra-large amounts of coarse dirt
- ✓ especially durable brushes
- ✓ resistant to weathering
- ✓ high abrasion resistance
- ✓ also suitable for outdoor use



Black

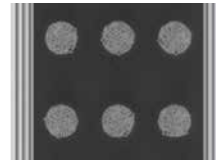

Grey

* not available in large (L) version

1 2 3 Dirt collection zone 2

Colours

Coarse fibre ribbed insert

- ✓ particularly resistant to abrasion
- ✓ very high dimensional stability
- ✓ extreme durability
- ✓ resistant to weathering

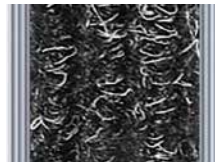

Anthracite 200



Light grey 220



Brown 485



Sand 430



Red 305

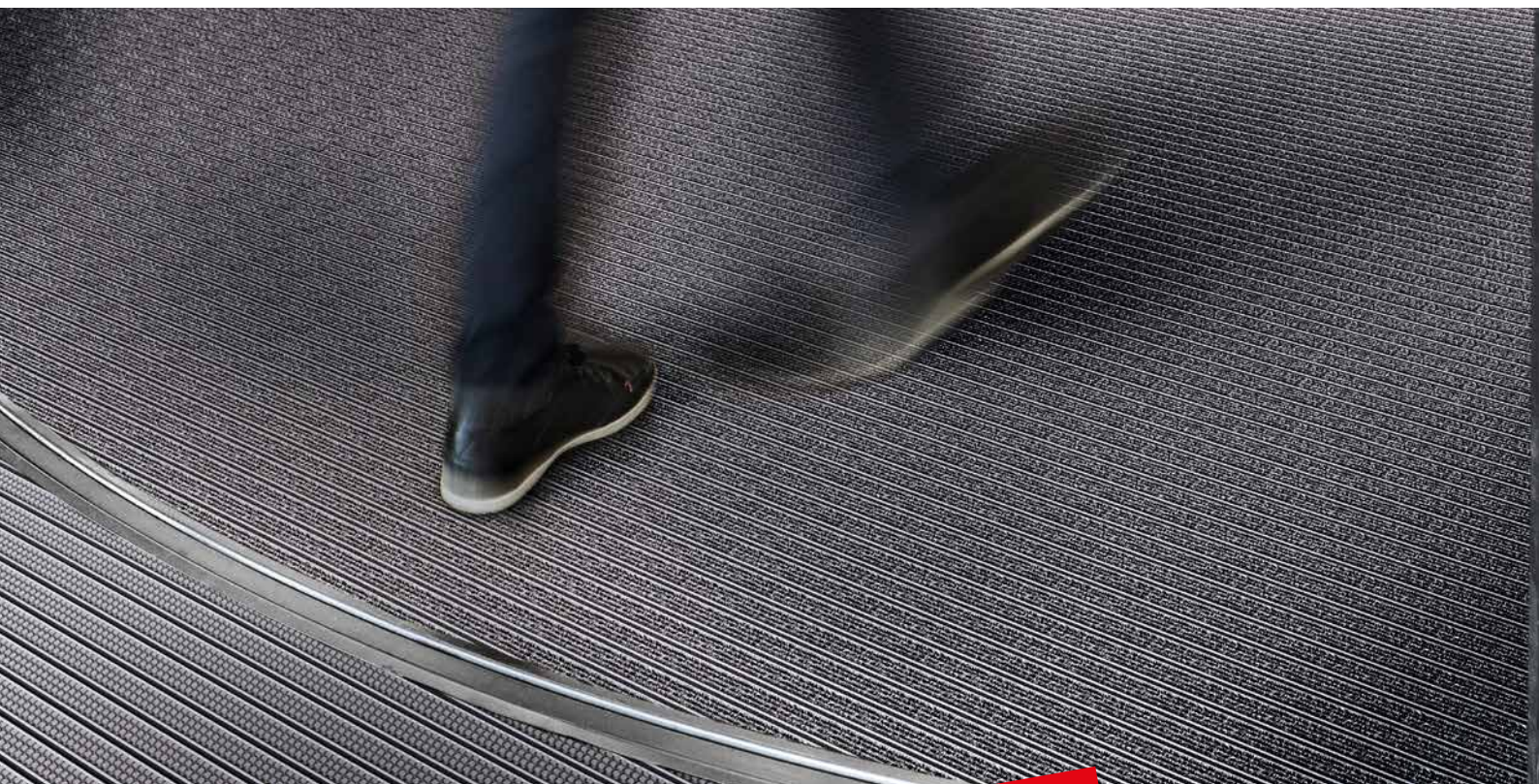

Our best seller:
22-mm height

The field of application

Depending on the type of load, you can choose between two different emco profiles for your entrance mat Original with Standard insert:

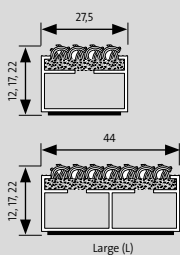

emco DIPLOMAT ORIGINAL

For entrances with normal to heavy loads

- e. g. for residential, administrative and office buildings
- heights: 12, 17, 22 mm
- ribbed inserts also available in a wide profile

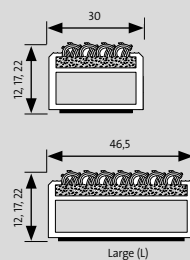

emco MARSCHALL ORIGINAL

For entrances with extreme loads

- e. g. for shopping centres, airports, hospitals and railway stations
- heights: 12, 17, 22 mm
- ribbed inserts also available in a wide profile



Dirt collection zones chosen independently

The cleaning boost for the entrance

You can structure your dirt collection zones individually so that you can benefit from the entire emco cleaning power, even when space is limited or the dirt load is particularly high. For example, you can combine inserts for different dirt collection zones to optimise dirt abrasion even when the installation length is limited. Additional emco profiles as well as the known profiles GCB, RCB and RG can be effectively combined to provide that extra cleaning effect. With separate scraper bars or brush strips fitted between the profiles, you can further increase the effectiveness of your emco entrance matting system.

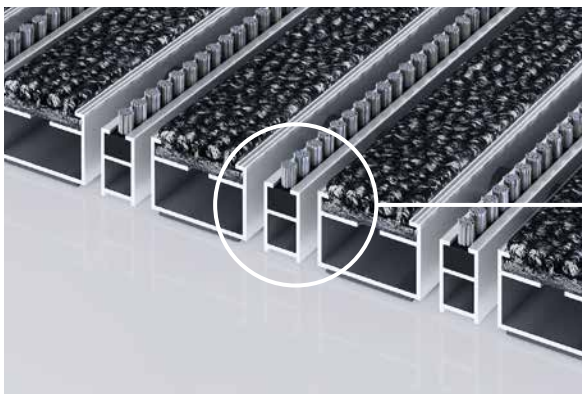

Combination with a brush strip (B)

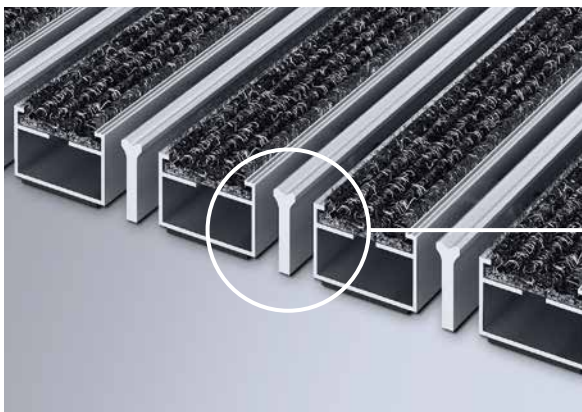

Combination with a scraper bar (K)



Combination of ribbed carpet and rubber insert (RC)

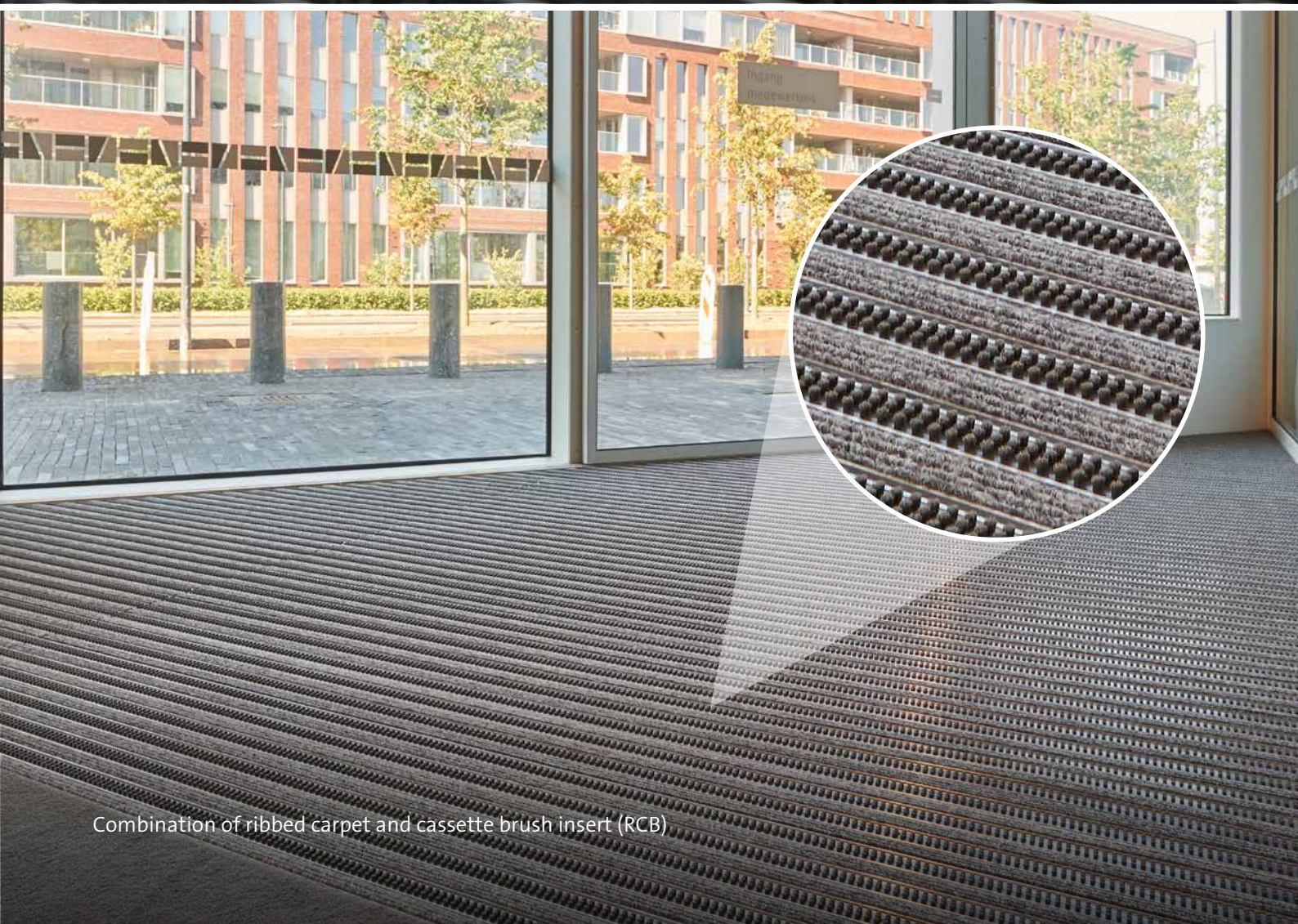

Combination of ribbed carpet and cassette brush insert (RCB)



emco installation frames and other accessories

The anchor for your entrance matting system

emco installation frames keep your entrance matting system safely under control. In the basic version, the frames consist of high-quality angle profiles and are available in a wide variety of designs. Whether made of aluminium, brass or stainless steel, rectangular or in special shapes especially for your building, the installation frames will win you over with their quality and flexibility. In addition to installation frames, our accessories also include cover strips and ramp edges. We will be happy to advise you.



emco installation frame 500,
aluminium



emco installation frame 500,
brass

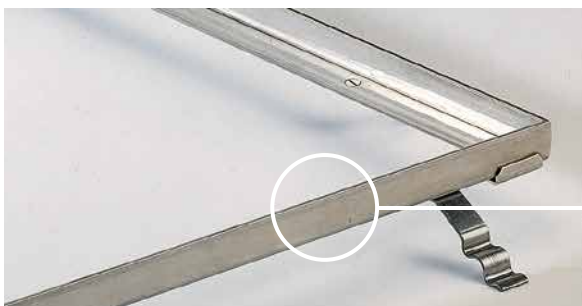

emco installation frame 500,
stainless steel

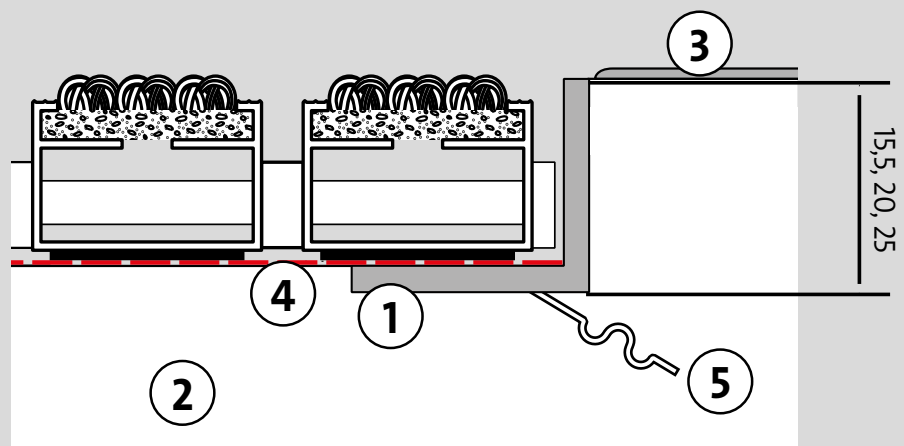

- emcoframe (1)
- screed (2)
- floor covering (3)
- mat well base (4)
- emcoframe anchor (5)

emco clean-off

How to preserve the quality of your floor

Internal floor coverings suffer a constant loss in value due to dirt, in most installations, the dirt and grit often leads to damage such as scratches, permanent stains or also loss of colour intensity in textile coverings. It is therefore worth planning as long a clean-off area as possible and giving the dirt collection zone 3 plenty of room. This also increases slip resistance enormously on the subsequent floors, since it absorbs a lot of moisture. Optimally set up, it thus protects people and floor covering and also maintains a well-kept, distinguished appearance for your entrance in the long term.

CARE



Anthracite 47.01 Grey 47.02 Brown 47.03 Beige 47.04

CONFORM



Anthracite 76.01 Brown 76.04 Beige 76.02

MAXIMUS

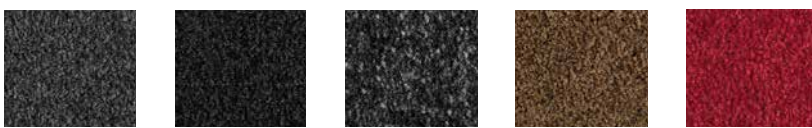

Anthracite 80.02 Black 80.01 Black mottled 81.01 Brown 80.04 Red 80.07

INNOVA

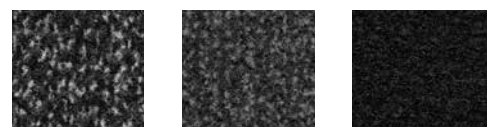

Anthracite 36.02 Grey 36.03 Black 36.01

Did you know that, ...

... thanks to special hollow fibres, their unique arrangement and the use of an extremely absorbent fleece, emco clean-off floor coverings can absorb a lot of dirt and moisture? Compared to normal carpeting, they are tufted with a lower stitch density. This allows dirt to fall into the gaps instead of remaining on the surface.

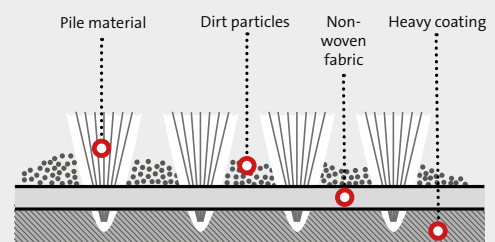



residual dirt and
moisture absorption



consistent
design



protection of the
subsequent floor covering



prevents accidents
caused by slipping



Deichtorcenter Hamburg (D)

Architects: BRT Bothe Richter

Teherani, Hamburg

Product: emco**MAXIMUS**

1

2

3

Clean-off in the entire building

Additional areas that are in need of dirt collection

Not only in the entrance area does sustainable protection from dirt pollution of all kinds pay off. This is why emco entrance matting systems are also the right choice inside the building when it is a question of preventing dirt from being distributed. Heavily frequented areas, such as canteens benefit from the safe protection of emco clean-off just as much as the coffee corner on the office floor.

Did you know ...

... that a clean-off protects not only the entrance area?

It reliably protects you from dirt accumulation, ensures that moisture is not carried on and is much easier to replace if necessary. Clean-off floor coverings are therefore not limited to the entrance area alone, but can be used throughout the building to maintain its value and create an attractive appearance.



emco special solutions

Special requirements? No problem!

Some entrances require unique or special solutions. It might be due to extreme loading in an industrial entrance, disabled access or an unusual layout.

Tactile

Entrance mat solutions for visually impaired and blind persons.

- ✓ SPIN® SAFE
- ✓ TLS
- ✓ MAXIMUS ASSISTANCE

Mat alternatives

Extremely resilient mats which ensure maximum cleanliness in the industrial sector.

- ✓ PLAZA
- ✓ KADETT

Modular/closed

A closed and extremely hard wearing reversible entrance mat suitable for surface or recessed installations.

- ✓ TWINGUARD
- ✓ GS 17
- ✓ AVIATOR

Rubber honeycomb mats

Highly versatile rubber honeycomb mats – robust, effective, universal.

- ✓ LIMBUS
- ✓ CUBUS
- ✓ STRUCTURA

Dirt collection wells

Indispensable in the case of excessive amounts of dirt accumulating in heavily frequented entrance areas.

- ✓ Dirt collection well
- ✓ Substructure

All further information on our emco special solutions can be found in our product brochures or on the Internet

🌐 www.emco-bau.com/special-solutions

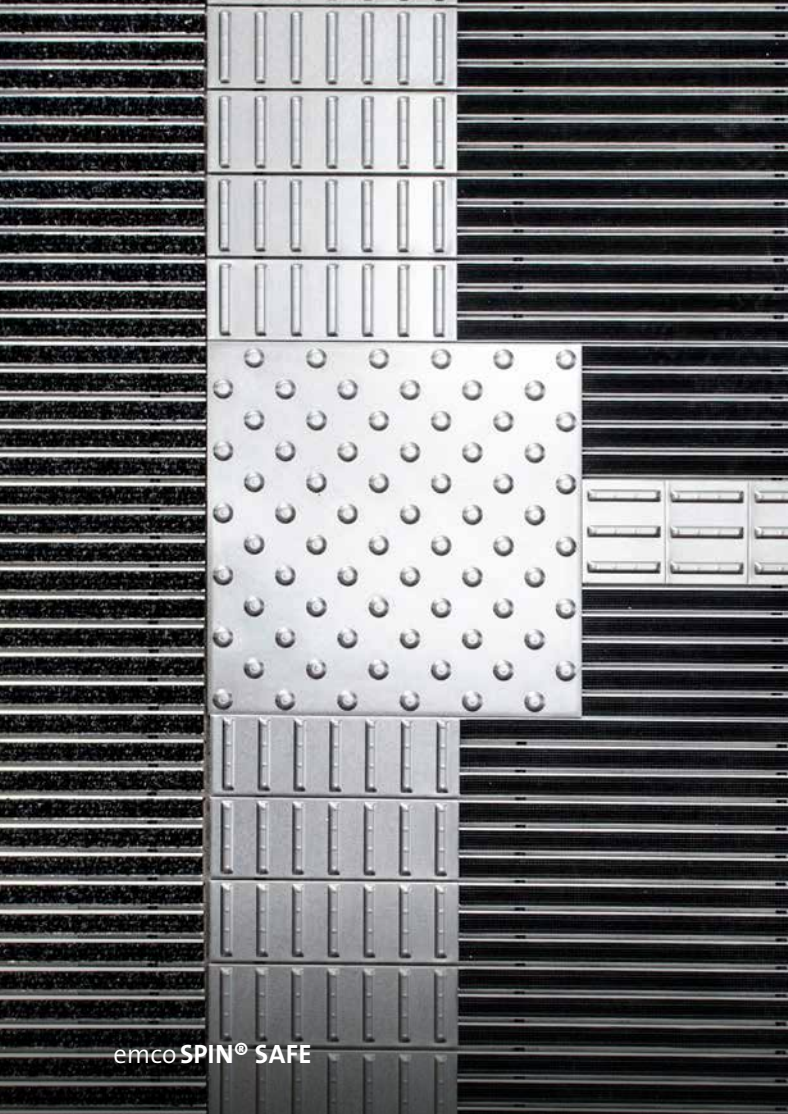

emco **SPIN® SAFE**

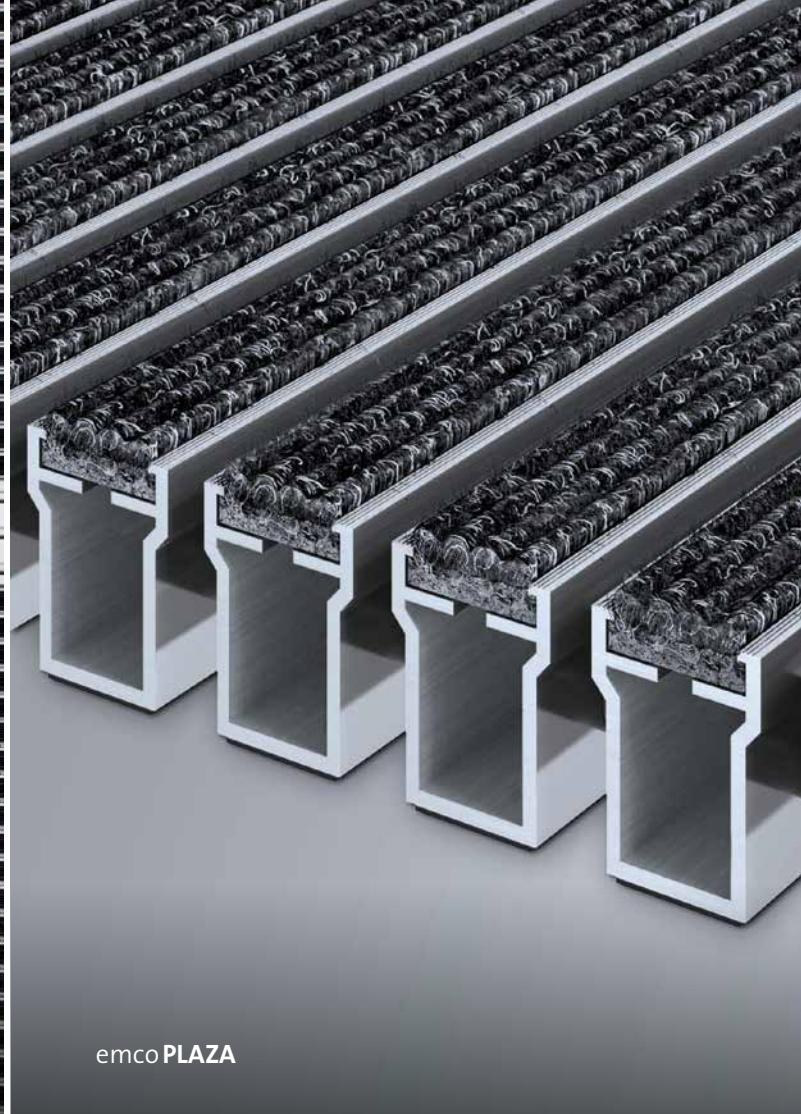

emco **PLAZA**



emco **TWINGUARD**



emco **dirt collection well**

emco special solutions

Personalised design for real eye-catchers

Individual entrances can be created with entrance matting systems by emco – not only in style and colour. Our special design options turn every entrance area into a real highlight – with curved mats, custom stainless elements and high quality illuminated frames. The ideal options, particularly for entrances with round shapes.

emco **LUMINA**

The LED illuminated frame system turns simple entrance areas into particularly stylish highlights.

- ☑ LUMINA
- ☑ LUMINA VIA

emco **MAXIMUS IMAGE**

The perfect design element with individual printing for creative and image-conscious people.

emco **INOX®**

Laser cut personalized stainless steel elements as advertising media – the finishing touch for the entrance mat.

- ☑ LINEO
- ☑ QUADRO

emco **T-PROFILE**

Aluminium profile for creating the visual separation of adjacent entrance mats.

emco **COLOR EDITION**

Aluminium profiles anodised in colour – for an even more colour-coordinated design for your entrance matting system.

emco **RADIAL**

A uniquely curved profile for a architecturally sophisticated properties.

All further information on our emco design solutions can be found in our product brochures or on the Internet

🌐 www.emco-bau.com/special_solutions



emco LUMINA VIA



emco MAXIMUS IMAGE



emco INOX® LINEO

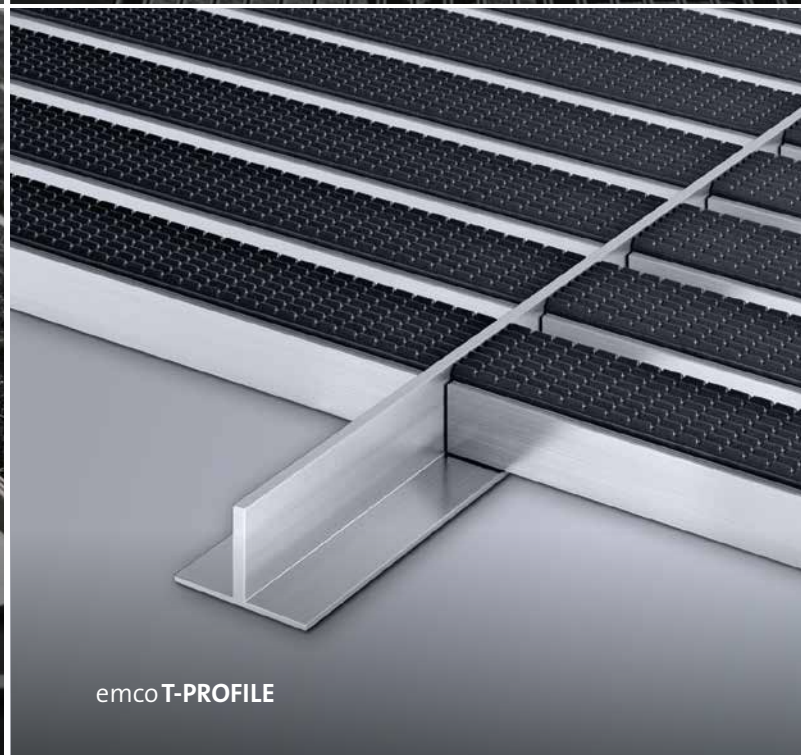

emco T-PROFILE

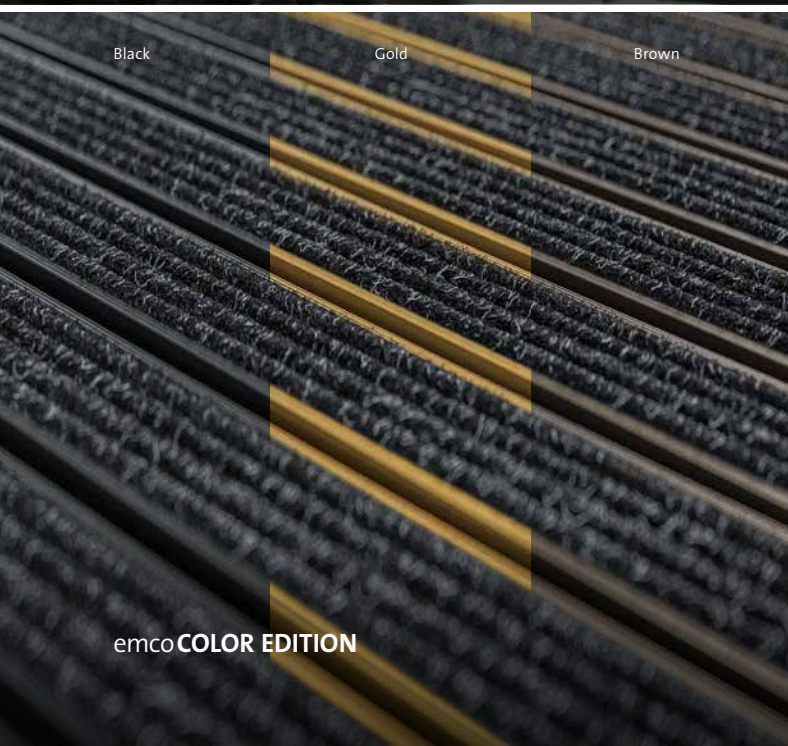

Black

Gold

Brown

emco COLOR EDITION

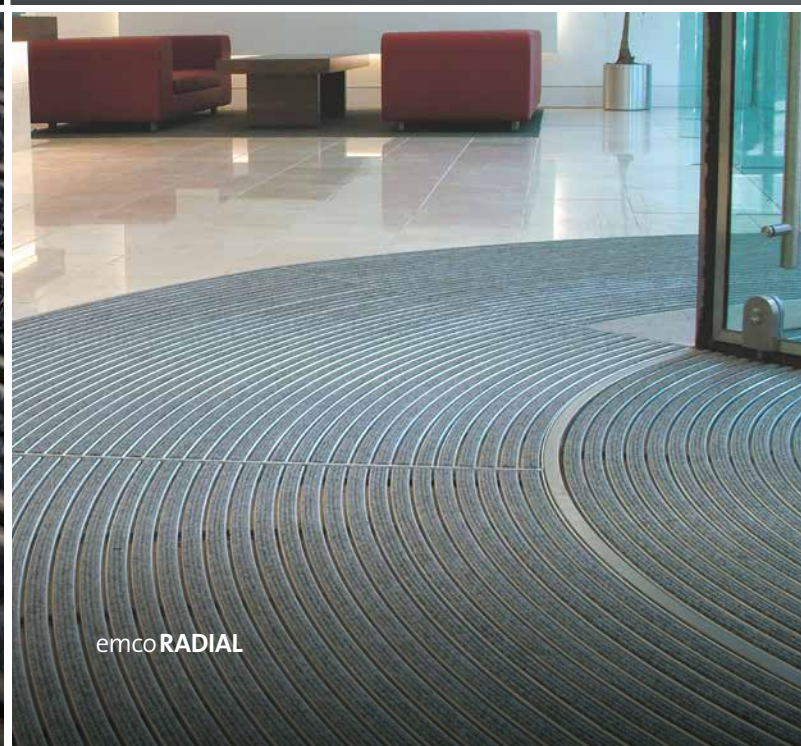

emco RADIAL

Services

360° service just in case

We want to make your everyday life as simple as possible: take advantage of our convenient services such as cleaning or site measuring. Our experts are always on hand to help. In addition to basic components, we also provide comprehensive accessories for the entrance area, giving you maximum freedom of design.

Consulting service

If you have any questions about a product, particularly tricky installation situations or comprehensive planning, simply contact us and we will support you.

Measuring service

Our experts can facilitate your planning enormously by measuring the entrance area with the help of a laser measuring device and their technical know-how.

Refurbishment service

Benefit from our replacement service. When emco systems need to be renovated, our professionals will either replace the inserts or, if necessary, the entire mat system.

Repair service

If you need a partial repair, such as the replacement of a profile, emco offers fast on-site service.

Installation service

For extra comfort: our professionals can carry out the complete installation of your emco entrance mats.

SERVICE-CONTACT

How to reach us:

Tel: +49 591 / 9140 - 501

bau@emco.de

www.emco-bau.com/service



Consulting service



Measuring service



Refurbishment service

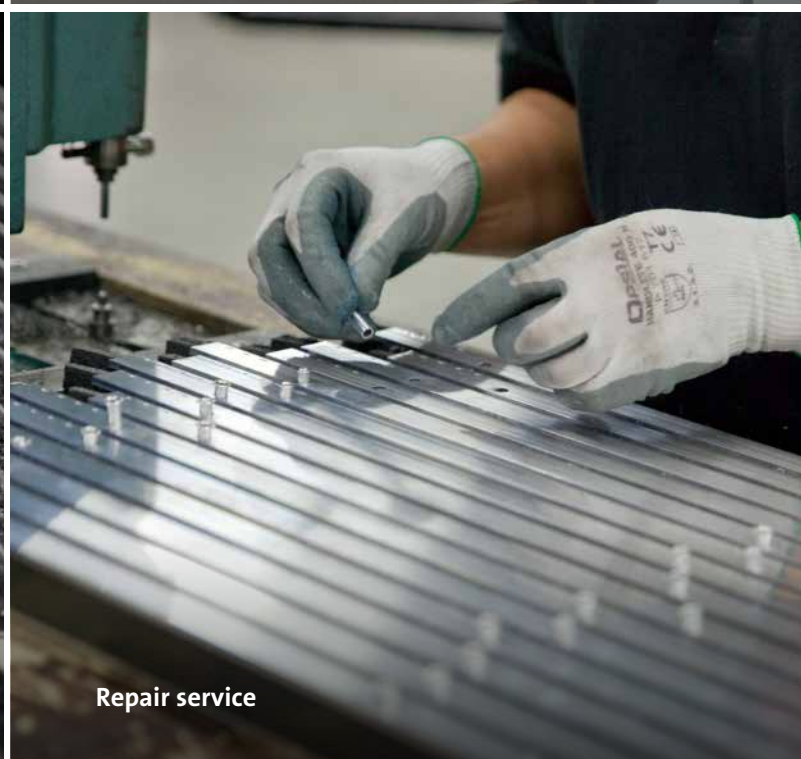

Repair service

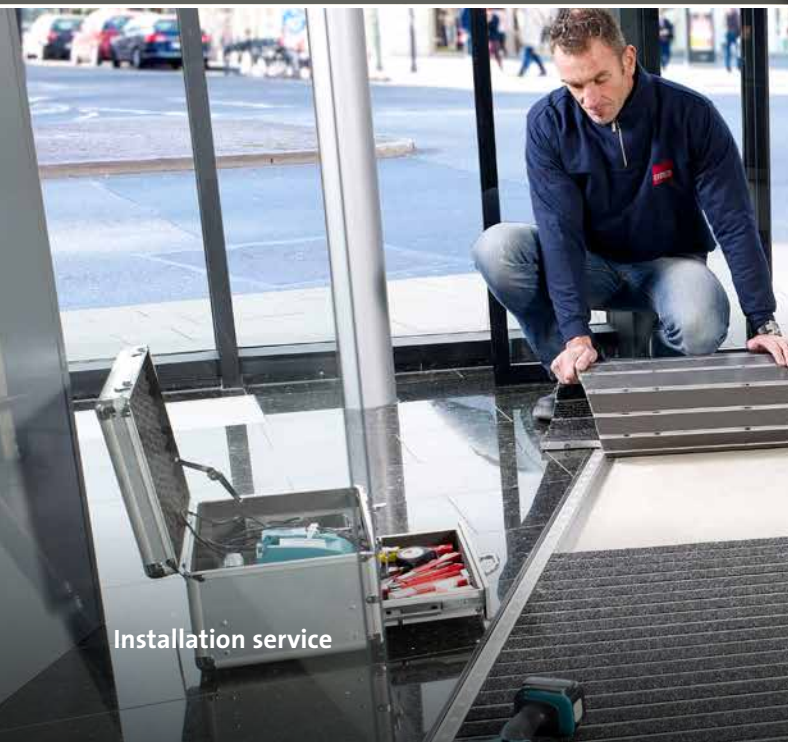

Installation service



International references

At home in the world

It is not only in Germany that people rely on the powerful protection of emco. Whether in Sweden, France or Belgium, wherever valuable architecture and highly frequented public buildings require reliable protection against dirt, clever operating companies, flooring experts and investors rely on the powerful 3-zone cleaning system.



Ozeaneum Stralsund, Germany
Architects: Behnisch & Partner



Palais Vest, Germany
Architects: Auer + Weber + Assoziierte



Emporia Malmö, Sweden
Architect: Gert Wingårdh



Liège railway station, Belgium
Architect: Santiago Calatrava



Auditorium AZ Groeninge Kortrijk, Belgium
Architects: Dehullu Architecten



Libeskind Villa, Germany
Architect: Daniel Libeskind

Certificates



Awards



Memberships/associations



More from emco:



emco carpet mats – individual in shape and design

Carpet mats by emco stand for top processing quality and maximum individuality. In addition to standard formats, shape mats are possible in almost any format. 45 bright standard colours as well as a bespoke colours can be created on request.

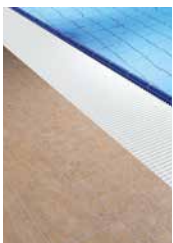

emco swimming pool grates – safe, hygienic and durable

Swimming pool grates by emco efficiently collect overflow water, are gentle on the feet and meet the highest safety and hygiene standards. The grates have an embossed safety profile and safety certification, they can also be produced in almost any shape.



emco service

We know how diverse project requirements can be. That's why we are happy to work with you to develop solutions for your project and offer many other practical services:

- telephone, digital and personal project guidance
- technical measuring service
- personal contact at www.emco-bau.com
- texts for invitation to tender at www.emco-bau.com

emco Bautechnik GmbH
Postfach 1860
D-49803 Lingen (Ems)
Germany
Tel. (+49) 591 9140 500
Fax (+49) 591 9140 852
bau@emco.de

emco UK Ltd.
5 Plough Road
Wellington
Telford
TF1 1ET
Tel. (+44) 01952 256446
Fax (+44) 01952 262940
enquiries@emcouk.co.uk

www.emco-bau.com

A member of the

