

Model C27

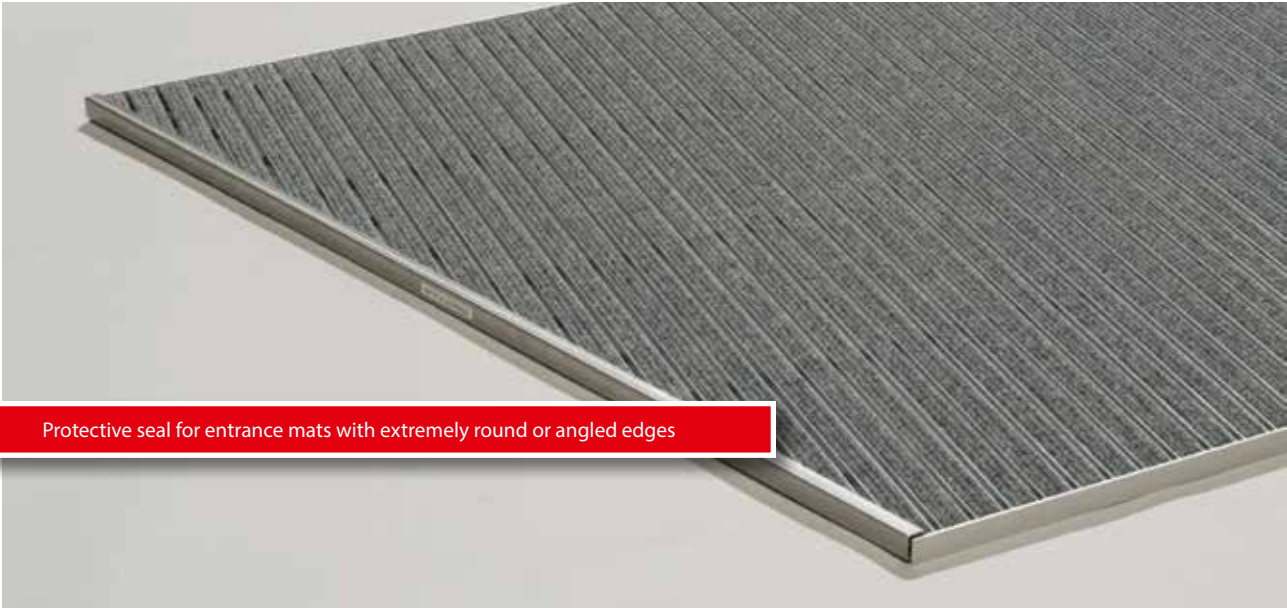

Protective seal for entrance mats with extremely round or angled edges

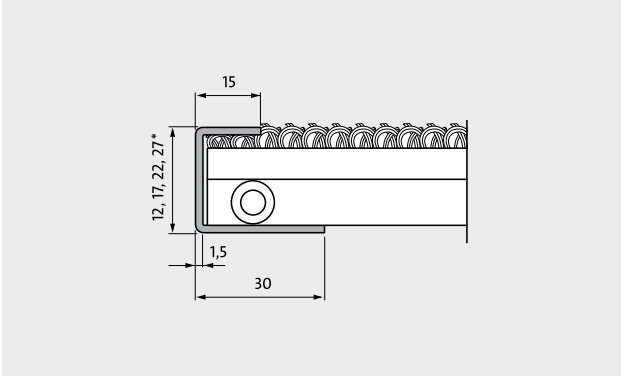

Description

Brushed and ground finish, designed to protect and cover mitred and angled edges in specially shaped entrance mats. Material: Stainless steel. For mat heights of 12, 17, 22, 27 and 42 mm. The actual cover strip heights may be greater, depending on the material used.



Outside (Zone 1)



Indoor and outdoor (covered, Zone 1+2)



Model C27

Description	Brushed and ground finish, designed to protect and cover mitred and angled edges in specially shaped entrance mats. Material: Stainless steel. For mat heights of 12, 17, 22, 27 and 42 mm. The actual cover strip heights may be greater, depending on the material used.
--------------------	--

Approx. material thickness (mm)	1,5
Height (mm)	27
Model	C27

Subject to technical modifications