

# Model 723/35

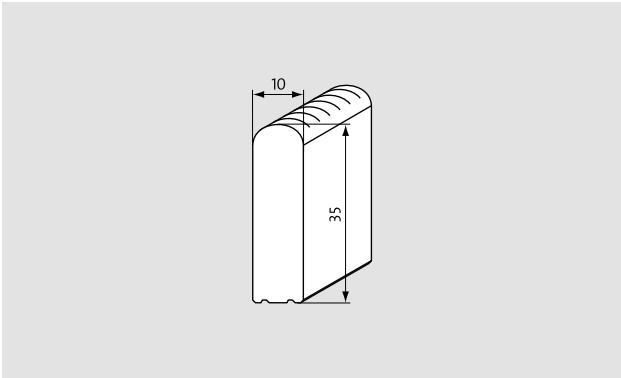

### Description

Swimming pool grating that is robust, solid and pleasant to walk on, which efficiently collects the overflow water at the edge of the pool and provides maximum safety and hygiene.



Non-slip properties in acc. with DIN 51097, classification C, angle of inclination  $\geq 24^\circ$



### Colours



White - similar to RAL 9010



Grey - similar to RAL 7001



Beige - similar to RAL 1001



Yellow - similar to RAL 1018



### Model 723/35

<b>Profile run</b>	Roll-up swimming pool grating with grating bars running at right angles to the pool edge
<b>Material</b>	High quality, extremely hard-wearing plastic, with UV absorber. Entirely corrosion-free and resistant to chlorine, sea water and spa water. No need for any metal parts; surface enclosed on all sides to provide maximum hygiene.
<b>Support chassis</b>	Full profile (35 x 10 mm)
<b>Finish</b>	Round upper profile surface with safety profile seal (SPS).
<b>Profile spacing:</b>	< 8 mm in accordance with DIN EN 13451-1 and DIN EN 16582-1 (to prevent areas where fingers could become trapped)
<b>Height (mm)</b>	35
<b>Connection</b>	Flexible PUR cord with interim spacer
<b>Slip resistance</b>	Non-slip in accordance with DIN 51097, classification C - tested by the „Institut der Säurefließner-Vereinigung“ (Säurefließner consortium)
<b>Variable grating width (mm)</b>	100-500
<b>Usage area</b>	Public and private swimming pools with overflow channels Whirlpools with overflow channels
<b>Dimensions</b>	Produced to fit width and depth perfectly without the need for alignment profiles
<b>During the winter season</b>	When not in use, the swimming pool gratings (if they are being used in open-air swimming pools) should be put into storage and covered with suitable protection to prevent unnecessary damage and soiling.
<b>Properties</b>	Excellent water drainage Easy to use Easy to clean Custom application options Freedom to create your own concept thanks to the additional special shapes on offer

## Model 723/35

### Service and services

Dimensioning

Installation service

Repairs

### Accessories

Mitred corner, self-supporting

Fan corner (135° - 179°)

Rigid corner (90°)

Angled profiles with dimensions of 25 x 28 x 3 mm or 28 x 25 x 3 mm suitable for swimming pool gratings with construction heights of 22 and 25 mm. For straight profiles only.

Blue information signs with rounded corners with white lettering engraved in them. They are lowered into the swimming pool grating surfaces by milling, and are permanently attached to the grating.

Blue information signs with rounded corners with white lettering engraved in them. They are lowered into the swimming pool grating surfaces by milling, and are permanently attached to the grating.

Pre-assembled version with angled profile dimensions of 25 x 28 x 3 mm or 28 x 25 x 3 mm suitable for swimming pool gratings with construction heights of 22 and 25 mm. For straight profiles only.

Subject to technical modifications